

FACADES

**FULLY SUPPORTED AND
RAINSCREEN SYSTEMS**

Guidelines for design and specification



VMZ Facade

Contents



- 3 **Why use VMZINC facades?**
- 4 **Sustainable performance**
- 6 **The systems**
 - Underlying principles
- 8 **Surface finishes**
- 10 **Fully supported facades**
 - 10. Standing seam
 - 14. Flat lock
 - 19. Adeka
- 20 **Rainscreen facades**
 - 20. VMZ Cassettes
 - 21. VMZ Composite
 - 24. Mozaik
 - 26. Customised panels
 - 30. Interlocking panels
 - 34. Sine Wave
 - 38. Overlapping panels
- 42 **Further technical information**
- 43 **Other VMZINC systems**
 - Roofing systems
 - Ornaments
 - Rainwater systems

Company profile VMZINC® has been manufacturing a wide range of rolled zinc products used primarily for building envelopes since 1837. In addition to batten cap and standing seam roof systems, products include rainwater systems, a wide range of cladding systems, including a number of rainscreen facade products. Since its creation the company has also produced decorative roofing products such as dormers, bull's eyes, weather vanes, finials and balustrades.



Front cover building credit: Scott Brownrigg Architects

VMZ Facade

Why use VMZINC facades?

Introduction Zinc is among the most sustainable metals used in construction today and was first used for roofing and gutters in large European cities at the beginning of the 19th century. Batten cap zinc panels were used for mansard roofs but towards the end of the 20th century architects began to use zinc as a way to clad facades. Over the past 20 years VMZINC has developed a range of facade systems that vary in dimension, joint size and type.

All VMZINC facade systems can be used for new build and refurbishment alike and in combination with many other building materials. As with all VMZINC products exceptional durability, very limited maintenance and a wide range of beautiful finishes are offered by VMZINC facades.

Benefits of the VMZINC facade systems

- Lightweight and durable
- Fully recyclable
- A service life of 100 years
- Virtually maintenance-free
- Complex shapes can be clad using VMZINC facades
- All flashings and trim can be in the same material
- EN 15804 Environmental Product Declaration
- Conforms to EN 988
- Available in a choice of either Natural zinc, engraved Azengar or 8 pre-weathered finishes
- Cost effective
- Wide range of panel types
- Fire classification A1 (Natural Zinc, QUARTZ-ZINC, ANTHRA-ZINC and AZENGAR) and A2-s1,d0 (PIGMENTO and VMZINC PLUS) according to EN 13501-1:2002

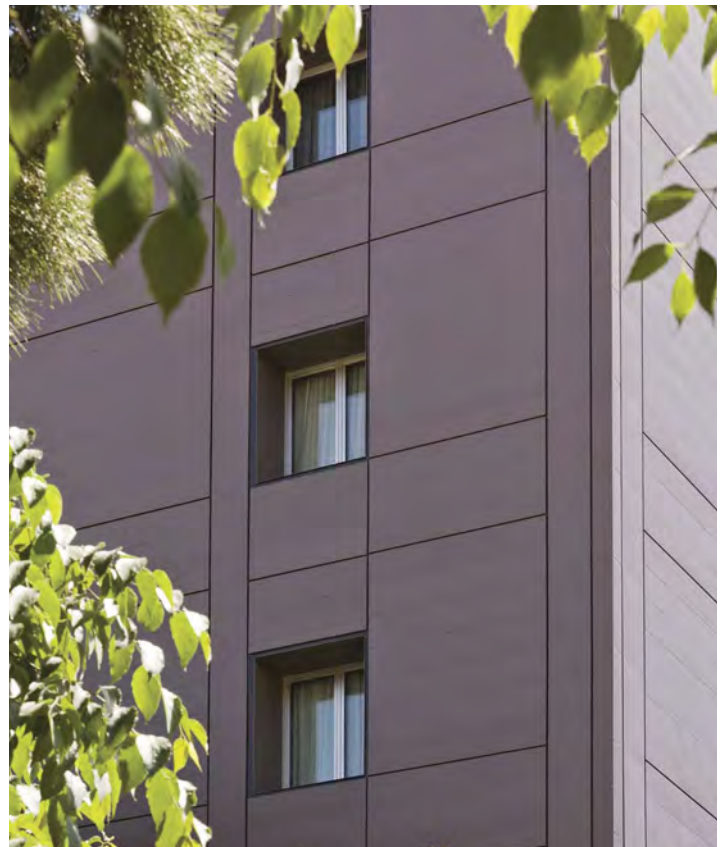

VMZ Facade

Sustainable performance

Low energy used in the manufacturing process

VMZINC rolled zinc products are used in construction industries throughout the world for their sustainability, distinctive appearance, and low maintenance requirements. As with roofing and rainwater systems, manufacturing processes for our facade systems presents a low environmental impact, particularly with regard to energy expenditure.

Low corrosion, long life

VMZINC facade systems benefit from zinc's self-protecting patina which develops as a result of exposure to water and carbon dioxide. Over the last 50 years the quantity of sulphur dioxide in the atmosphere has been greatly reduced. SO₂ being the key agent of corrosion means that corrosion rates are now less than 1µm per year on facades. With an initial thickness of 1mm, the estimated life span of a zinc facade is well over a hundred years.

Recycled material

95% of old rolled zinc recovered every year in Western Europe, currently estimated at 100,000 tonnes, is reused. This represents savings in mining resources of between 1 and 2 million tonnes.

A natural material

VMZINC undertakes Life Cycle Analysis (LCA) tests on its products and publishes Environmental Product Declarations (EPDs), such as BRE Environmental Profiles, available from our website www.vmzinc.co.uk and www.greenbooklive.com. These provide users with comprehensive, reliable and transparent information on relevant environmental characteristics. The information is also used by VMZINC as the basis for its eco-design approach.

Comparative energy expenditure in manufacture

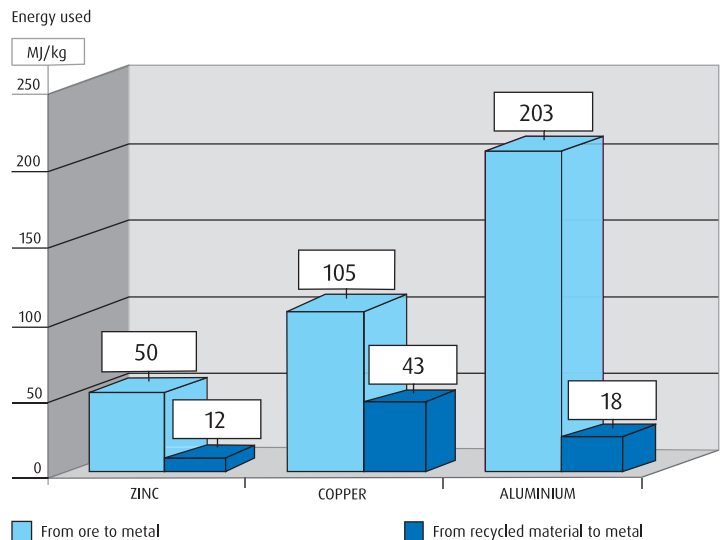

Compared with other metals, very little energy is needed to manufacture zinc metal from ore – less than half the consumption of copper and stainless steel and less than a quarter of that used for aluminium. CO₂ and other greenhouse gas emissions are also, therefore, proportionally less.

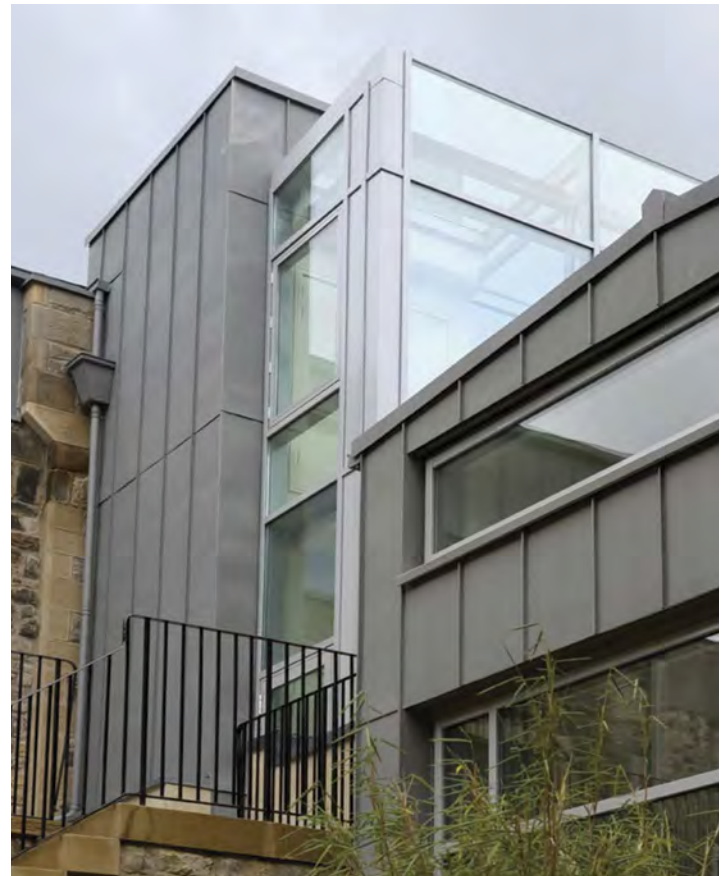

VMZ Facade

Sustainable performance



Environmental profiles measure the impacts of a construction material, product or building system throughout its life, not only during its manufacture, but also its use in a building over a 100 year period. This includes its extraction, processing, use and maintenance and its eventual disposal.

VMZINC is a member of BRE Global's certification scheme and carries Environmental Product Declarations in accordance with EN 15804 for Natural Zinc, QUARTZ-ZINC, ANTHRA-ZINC, the PIGMENTO range as well as VMZINC PLUS.



All of VMZINC production plants are conform to ISO 14001 creating a high level of quality control with regards to the environment.

Quality management certification ISO 9001 also applies to not only all production plants but also to all services and products.

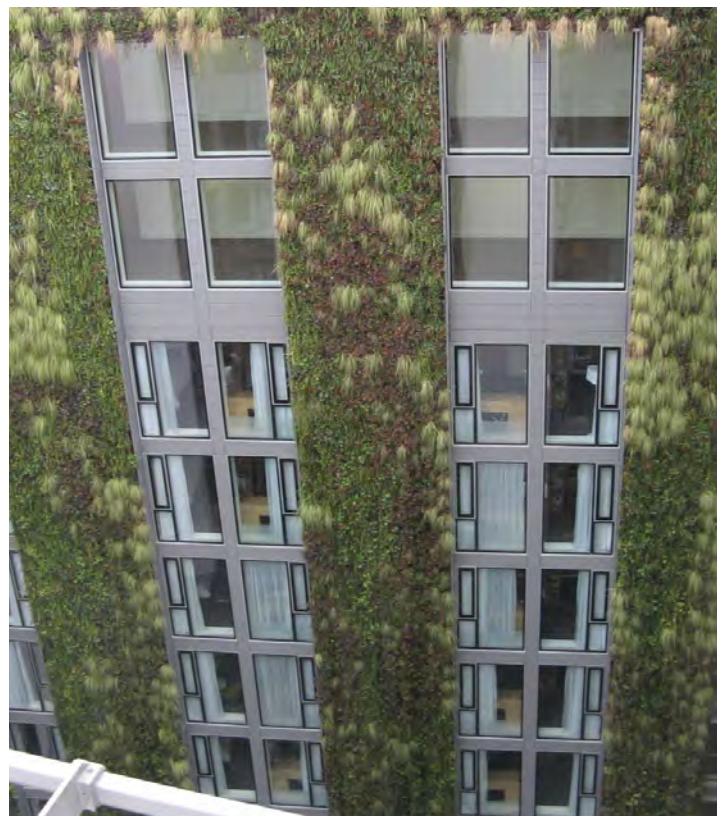

VMZ Facade

The systems

Underlying principles

Introduction VMZINC has been used as a material to clad facades for many decades. Initially traditional roofing systems such as standing seam panels were installed as 'roofs on walls'. Flat lock panels have also been installed for many decades. Both of these systems require vented continuous substrates and are commonly installed by traditional hard metal roofing contractors. Over the past two decades rainscreen facades have become very popular and VMZINC offers a number of these rainscreen systems.

Rainscreen facades A rainscreen facade is an outer skin that is back-ventilated by an air space that is 38mm deep. The system can be used on both new build and renovation but always allows the outer layer to breathe whilst the inner layer deals with thermal insulation and air leakage. All joints are dry and do not use any form of sealant.

Joint types VMZINC wall panels can be joined using three mechanical joints:

- Standing seam
- Flat lock
- Reveal

VMZINC PLUS VMZINC PLUS is a unique patented product that allows zinc to be installed on ventilated plywood (page 10).

The product consists of VMZINC (in all finishes) having a 60 µm coating applied to the underside thus allowing a more varied amount of substrates to be used and eliminating the risk of the formation of white rust on the underside of the zinc standing seam panels. VMZINC PLUS resists to an abrasion of 140 litres when tested in accordance with ASTM D 968.

Non Vented Warm Walls

VMZINC PLUS can be used to clad non vented warm wall construction using standing seam and flat lock panels on substrates such as insulated metal sandwich panels. It is vital that the designer obtains acceptance from Building Control prior to installation.

Developments over 18m high (non or limited combustibility) For buildings where combustible materials such as plywood cannot be used (for example residential developments over 18m in height), galvanised steel decks can be used as a substrate for the flat lock and standing seam panels. By combining this with mineral board insulation, all materials in the wall build up are A1 or A2 according to EN 13501. The steel deck must be at least 0.7mm thick and have dimensions allowing clips to be attached at the required spacings. Corrugated steel deck can only be used on vertical surfaces. For all surfaces such as sills, parapets, etc the substrate must be continuous. The 38mm vented cavity can be fire stopped using continuous vertical cavity barriers and intumescent horizontal cavity barriers.

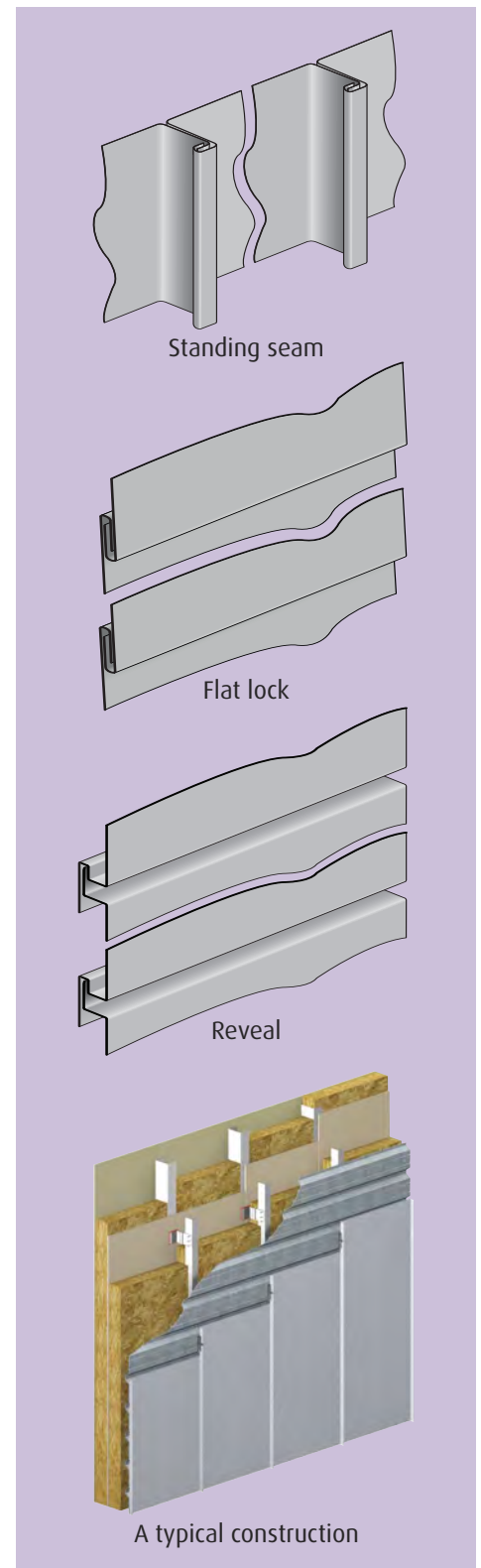

VMZ Facade

The systems

Underlying principles

Please contact us
for further
design assistance

Panel size and flatness

VMZINC wall panels will offer very different aspects depending on the type of panel used. Whilst standing seam panels can offer a continuity from roof to wall they will not offer absolute flatness. Flat lock panels also offer a more textured finish. The interlocking panel system provides flat panels but they are limited to 333mm in width. VMZ composite material on the other hand can offer excellent flatness whilst maintaining panels of up to 1100mm wide. For panels between 333mm and 600mm in width, Mozaik panels should be considered – see pages 24-25.

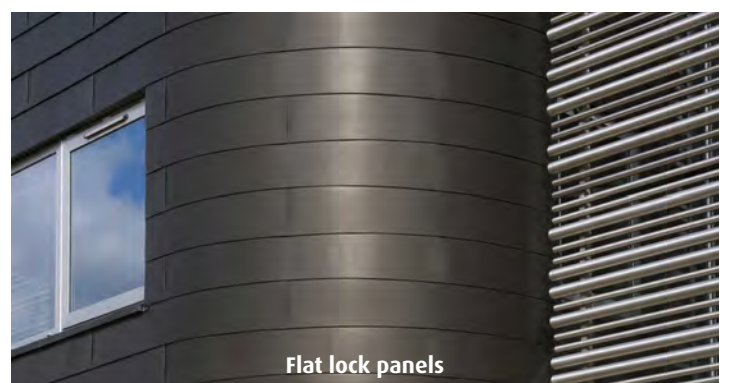
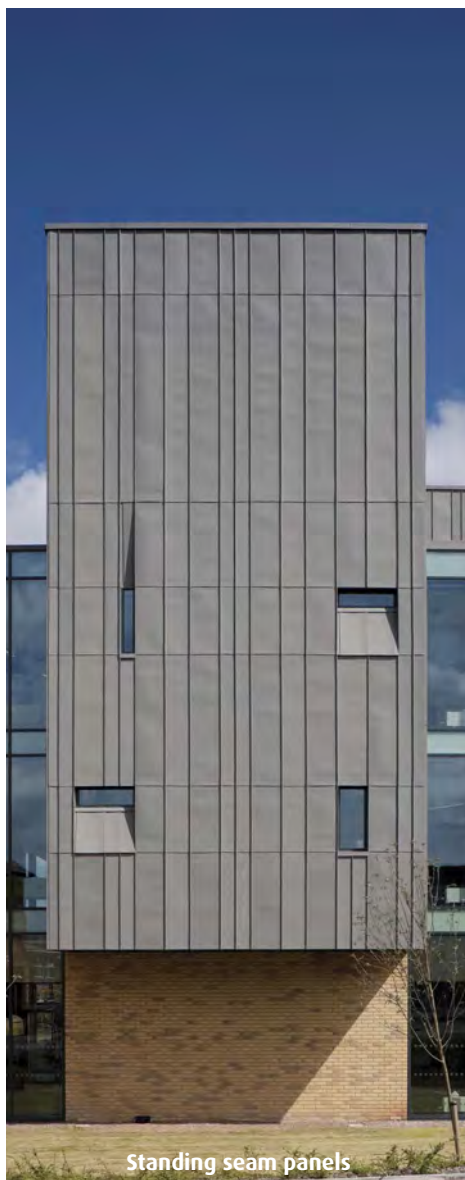
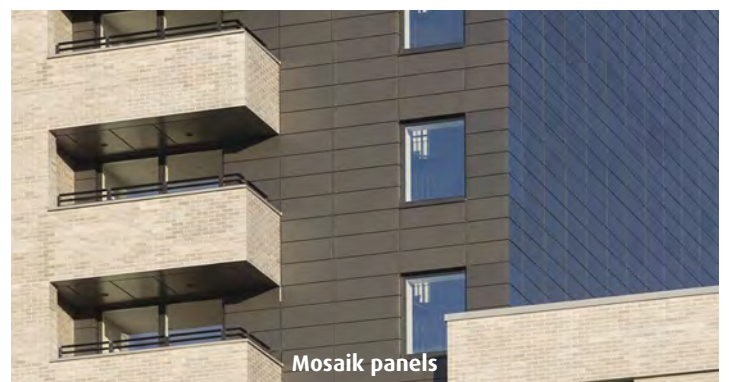
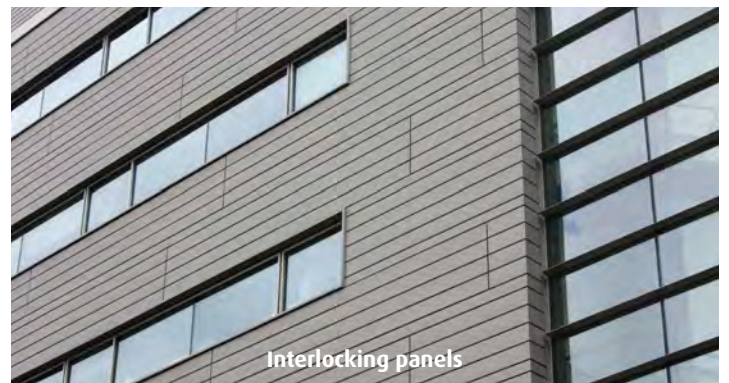

VMZ Facade

Surface finishes

Natural VMZINC® Natural VMZINC has a shiny metallic appearance when new and develops a patina over time. In facade applications, it may take 10 years for the matt grey patina to form. It can be quickly soldered without removing the patina.

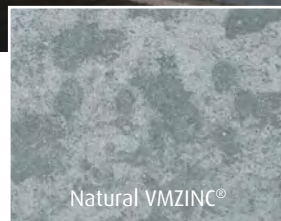

QUARTZ-ZINC® QUARTZ-ZINC offers an appearance and texture that does not change over time. When QUARTZ-ZINC is scratched, it will self heal. The grey tones of QUARTZ-ZINC blend well with existing construction materials – ideal for refurbishment.



ANTHRA-ZINC® ANTHRA-ZINC with its visible grain matches the colour of slate and blends well in combination with photovoltaic panels. Due to the dark aspect of the material salt stains are possible in coastal environments especially on non-rinsed (rain water) surfaces.

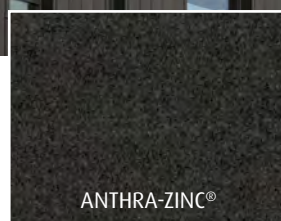

AZENGAR® AZENGAR is the surface finish from VMZINC which is the first engraved zinc giving a product with a matt, heterogeneous and light aspect. AZENGAR can be used in the same fashion as other VMZINC products for both roofs and facades.



VMZ Facade

Surface finishes

Please contact us for samples

Standard PIGMENTO®

PIGMENTO finishes offer a unique range of colours (Blue, Green, Brown, Red and Grey) that enhances any building. This natural product enables the texture of the QUARTZ-ZINC to still be seen whilst offering the designer the choice of colour to complement other elements of a facade or roof.

The colouration of the zinc is achieved with a special pigment layer that enhances the qualities of the zinc without presenting a block colour. This product is tested to EN13523-10/2010 and EN 15523-3/2001.

PIGMENTO, available in five standard colours, provides an increased resilience, however in a severe non-rinsed marine environment (1km from the sea), staining is still possible and therefore the material should not be used in this application.

Bespoke PIGMENTO® New

The PIGMENTO range is now available in bespoke colours. Samples of the colours indicated here are available upon request. For other colours a sample and RAL colour should be submitted in order to assess feasibility.



Standard PIGMENTO® BLUE



Standard PIGMENTO® GREEN

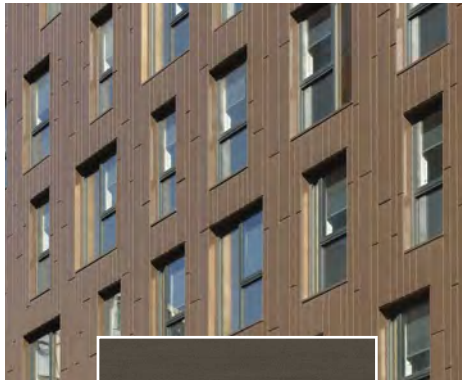

Standard PIGMENTO® BROWN

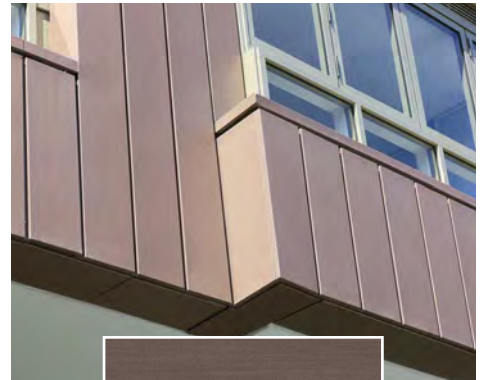

Standard PIGMENTO® RED



Bespoke PIGMENTO® colours



Standard PIGMENTO® GREY

VMZ Facade

Standing seam

Typical standing seam panel system construction



Note:
Supporting structure is indicative and can be blockwork or metal framing with a non-combustible deck or other appropriate materials.



Maximum panel size: 430 x 4000mm

- 1 VMZ standing seam panels in VMZINC PLUS
- 2 Fixing clip
- 3 18mm plywood or steel deck (see page 6)
- 4 Battens creating a vented 38mm airspace
- 5 Insulation protected by VMZ Membrane

Advantages of the standing seam panel system

- Covered by Code of Practice 143-5: 1964
- Concealed fasteners
- Roof to wall continuity
- Versatile
- Horizontal, vertical and diagonal installation possible

For more information contact us on
0203 445 5640
or send an e-mail to
vmzinc.uk@vmbuildingsolutions.com

VMZ Facade

Standing seam

Overview VMZ Standing Seam is a ventilated cladding system that can be used for both renovation and new build. As the name standing seam implies, the system consists of seams that can be crimped in a single or double lock (for greater flatness single lock seams sometimes referred to as angle seams are recommended). The system has a traditional look with the seams being 25mm high. The trays can be installed horizontally, vertically and at an angle.

This facade system offers the possibility to clad all types of walls: flat, curved or complex forms. Another great advantage of this zinc facade system is that it can be used on both walls and roofs, thus allowing roof and wall to blend as one (standing seam roofs require double lock seams). The cladding panels can be various sizes but we would not recommend that they be more than 4m in length and 430mm in width. Single lock panels should not exceed 430mm in width. All aspects of VMZINC can be used with 0.8mm being the recommended thickness for facades.



VMZ Facade

Standing seam

Structure The system is very lightweight as the panels weigh no more than 7 kg/m² and can be fixed back to both soft wood open gap boarding and plywood. Both substrates require the use of 18mm thick wood and a vented airspace should be left behind the timber of at least 38mm. The plywood must be weather and boil proof. WBP plywood is more precisely described as EN314-2 (bond class 2) and EN636-2 (timber performance). When soft wood open gap boarding is used it is possible to omit every other board, however a fully boarded substrate should be used in accessible areas. The substrate must be flush to within 2mm and all screws and nails must be countersunk. VMZINC PLUS must be used on plywood substrates, however for vertical surfaces VMZINC and VMZ Membrane can be used on vented plywood. For projects where combustible materials such as plywood cannot be used galvanised steel decks can be used as a substrate – see page 6 for further information.

Installation The panels are installed in a sequential order from either left to right or right to left for vertical panels. Horizontal panels must be installed from bottom up. For panels less than 2m in length fixed clips can be used. For longer panels sliding clips must be used towards the bottom on vertical panels and to the left and right of the centre for horizontal panels. When using single lock all clips can be fixed. VMZINC clips are made from 304 stainless steel and each clip must resist a pull-out force of 50 daN. It is recommended that screws be used to secure the clips with three being used per sliding clip. The use of nails offers significantly less resistance, but in the event of using nails, contractors are advised to use ring shank nails.

The panels should be installed with the protective film in place.

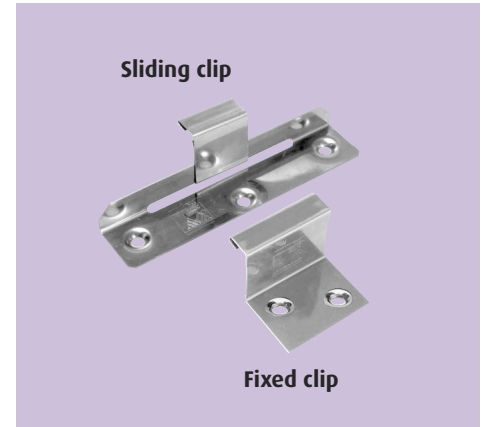

Centre to centre distance between clips:

- 330mm on the main part of the facade
- 200mm on perimeter of the facade (at least 1100mm from building corner)
- 150mm in corner areas



VMZ Facade

Standing seam

Download the technical drawings of this facade build-up from our website www.vmpzinc.co.uk

Corner details

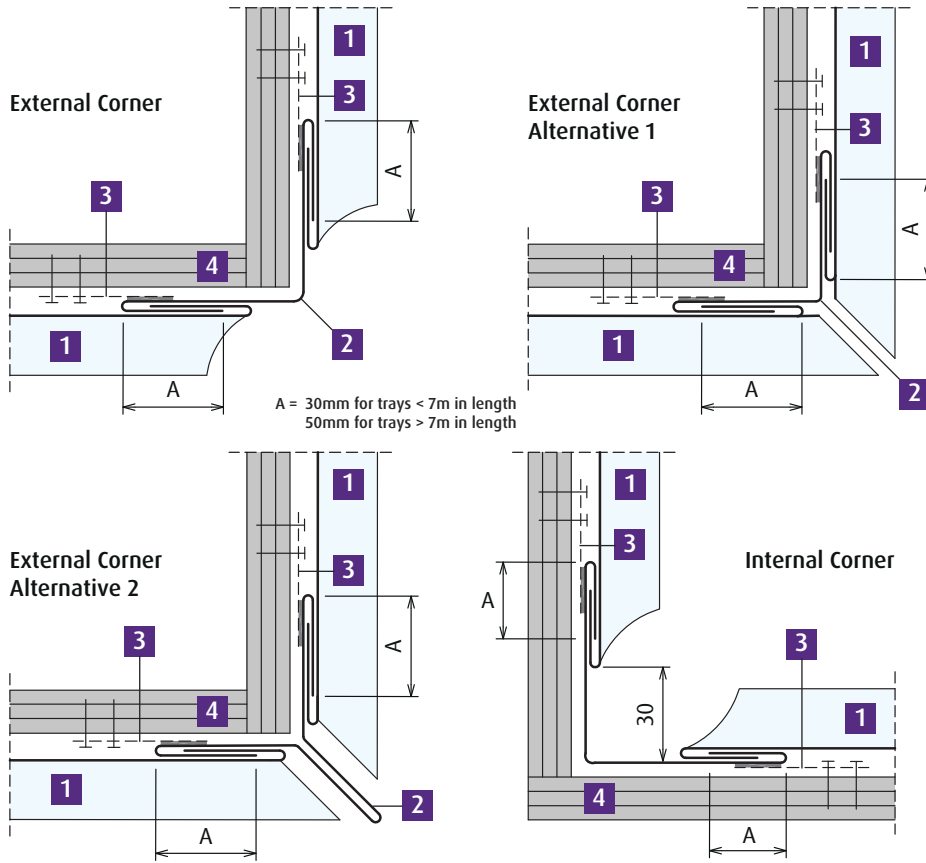

- 1 VMZINC PLUS Standing Seam
- 2 VMZINC PLUS continuous corner strip
- 3 VMZINC PLUS soldered clip
- 4 Plywood

Window details

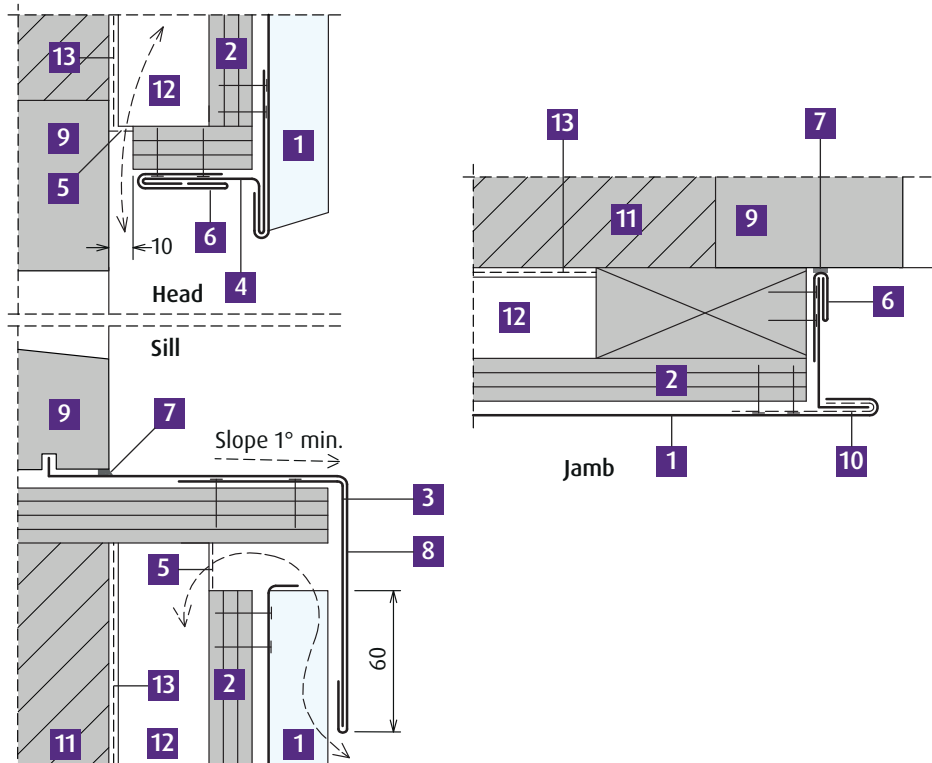

- 1 VMZINC PLUS Standing Seam
- 2 Plywood
- 3 VMZINC PLUS continuous folded strip
- 4 VMZINC continuous folded strip, 0.7mm thick
- 5 Insect mesh
- 6 VMZINC continuous folded strip
- 7 Compatible mastic sealant
- 8 VMZINC PLUS flashing
- 9 Window frame
- 10 VMZINC PLUS sheet clip, 0.7mm thick, width 80mm, 2 per m
- 11 Loadbearing structure
- 12 Ventilated space
- 13 VMZINC Membrane

All dimensions in mm

VMZ Facade

Flat lock

Typical
flat lock
panel system
construction



Note:
Supporting structure is indicative and can be blockwork or metal framing with a non-combustible deck or other appropriate materials.



Maximum panel sizes: 600 x 1000mm
530 x 2000mm
430 x 3000mm

- 1 VMZ flat lock panels in VMZINC PLUS
- 2 Fixing cleat
- 3 Fixing strip
- 4 18mm plywood or steel deck (see page 17)
- 5 Battens creating a vented 38mm airspace
- 6 Insulation protected by VMZ Membrane

Advantages
of the
flat lock
panel system

- Covered by Code of Practice 143-5: 1964
- Concealed fasteners
- Offers great flexibility on panel size and shape

For more information contact us on
0203 445 5640
or send an e-mail to
vmzinc.uk@vmbuildingsolutions.com

VMZ Facade

Flat lock

Overview VMZ Flat Lock panels, sometimes known as shingles, are installed on a continuous vented substrate on both renovation projects and new build alike. The system consists of panels with 180 degree hems approximately 25mm wide that interlock and are held on the substrate using cleats. The system allows a great deal of flexibility as flat lock panels can be made to many shapes and sizes. The panels can be square, diamond shaped and rectangular. The maximum recommended visible width for a panel is 600mm with the maximum length being 3000mm. The thickness of the zinc used will depend on panel dimensions with small panels using 0.7mm zinc whereas the larger panels will require 1mm thick zinc. Increased zinc thickness will offer a flatter panel, however increasing panel dimensions will have the opposite effect and may induce some unevenness.

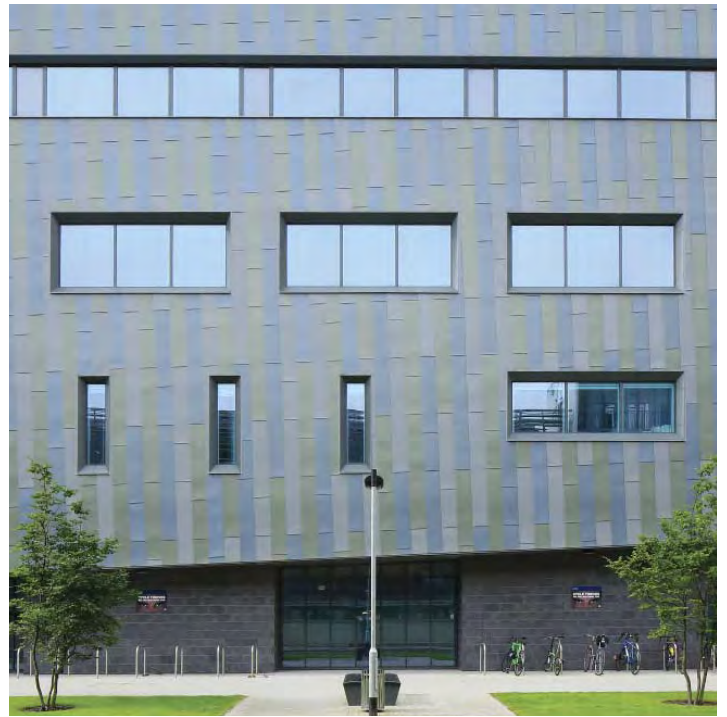

VMZ Facade

Flat lock

Structure The system is very lightweight as the panels weigh no more than 8 kg/m² and can be fixed back to both soft wood open gap boarding and plywood. Both substrates require the use of continuous 18mm thick wood and a vented airspace should be left behind the timber of at least 38mm. VMZINC PLUS must be used on plywood substrates. For vertical surfaces VMZINC can be used on vented plywood with VMZ Membrane. When non-combustible substrates are required plywood can be substituted with 0.7mm galvanised steel deck.

Installation The panels are installed in a sequential order from bottom up. The panels are held in place using cleats which can be stainless steel, zinc or galvanised steel. For larger panels galvanised steel cleats are recommended. The cleats should be fixed at a maximum of 330mm centres. For small diamond shaped panels the hems should be slightly notched thus allowing the cleat to sit securely. When installing large rectangular panels the short side should be fixed with a long fixing strip. It is recommended that screws be used to secure the cleats. The use of nails offers significantly less resistance, but in the event of using nails, contractors are advised to use ring shank nails. The panels should be installed with the protective film in place.

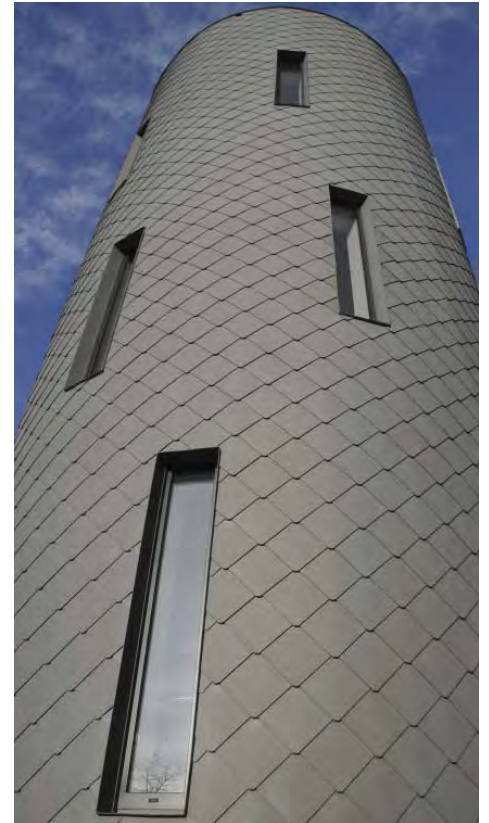

VMZ Facade

Flat lock

VMZINC standard flat lock panel sizes

The sizes and shapes indicated in this table are standard and are therefore more cost effective than completely bespoke sizes. The sizes indicated correspond to dimensions as seen on the finished wall. Diamond shingles are as standard supplied with non-aligned joints. All panels are delivered with stainless steel clips.

Standard flat lock panel sizes

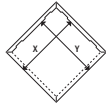
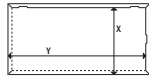
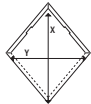
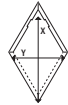
Pattern	Width X (mm)	Length Y (mm)	Nos of clips	Pieces per/m ²
Square 	235	235	2	19
	420	420	4	6
	590	590	4	3
Rectangle 	235	470	3	10
	235	940	4	5
	420	630	5	4
	420	840	6	3
	590	885	6	2
Diamond - Wide 	274	215	2	33
	290	230	2	29
	432	336	2	14
Diamond - Narrow 	371	193	2	27
	391	206	2	24
	585	301	2	11

Please contact us for other sizes

Galvanised steel deck used as a substrate for flat lock wall panels



VMZ Facade

Flat lock

Download the technical drawings of this facade build-up from our website www.vmzinc.co.uk

Corner details

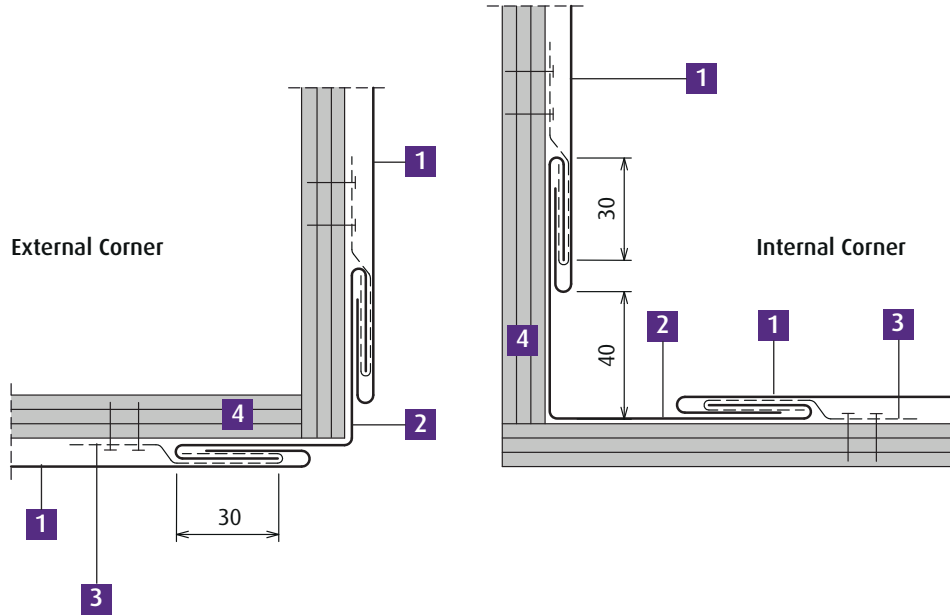

- 1 VMZINC PLUS Flat Lock Panel
- 2 VMZINC continuous corner strip
- 3 VMZINC PLUS sheet clip
- 4 Plywood

Window details

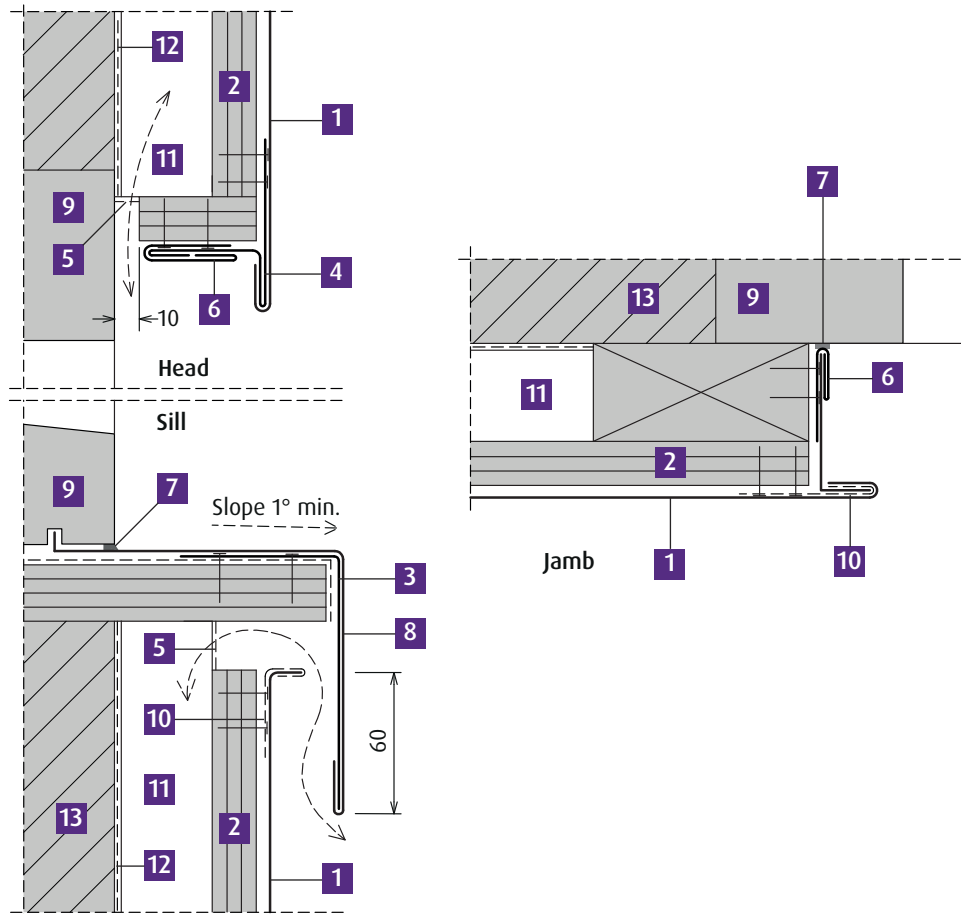

- 1 VMZINC PLUS Flat Lock Panel
- 2 Plywood
- 3 VMZINC PLUS continuous folded strip
- 4 VMZINC continuous folded strip, 0.7mm thick
- 5 Insect mesh
- 6 VMZINC continuous welted strip
- 7 Compatible mastic sealant
- 8 VMZINC PLUS flashing
- 9 Window frame
- 10 VMZINC PLUS sheet clip, 0.7mm thick, width 80mm, 2 per m
- 11 Ventilated space from 20 mm to 38mm
- 12 VMZINC Membrane
- 13 Loadbearing structure

All dimensions in mm

VMZ Facade Adeka

Overview Adeka is an innovative patented facade and roof system based on small pre-formed QUARTZ-ZINC elements featuring a unique locking key. For other finishes please contact us.

8.8 elements are required to cover 1m². Due to the raised edges and 50mm overlaps Adeka can be used for roofing for slopes of 15 degrees and over.

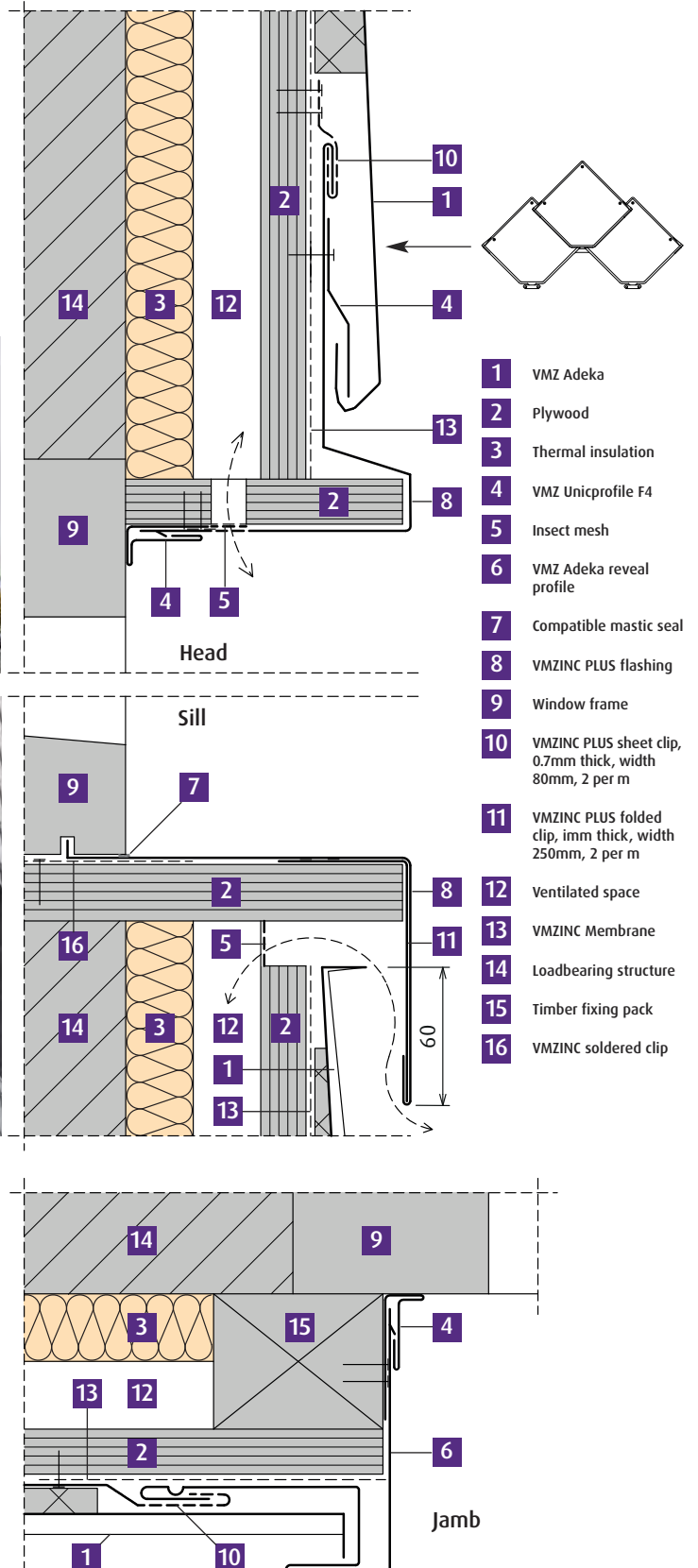

Installation and structure

Adeka can be fixed to both vented open gap softwood boards and vented 18mm plywood with VMZINC Membrane. The panels are installed from bottom up with the key fixing into the lower panel. Each Adeka tile is then secured with 3 screws. Adeka is not supplied with filmed VMZINC.

VMZ Facade

VMZ cassettes

Overview In recent years zinc has been used far more as a metal for rainscreen cassettes. The system used will vary depending on panel size/format, joint type and whether fixings are visible or not and panel flatness.



VMZ Facade

VMZ composite

Typical
VMZ composite
system
construction

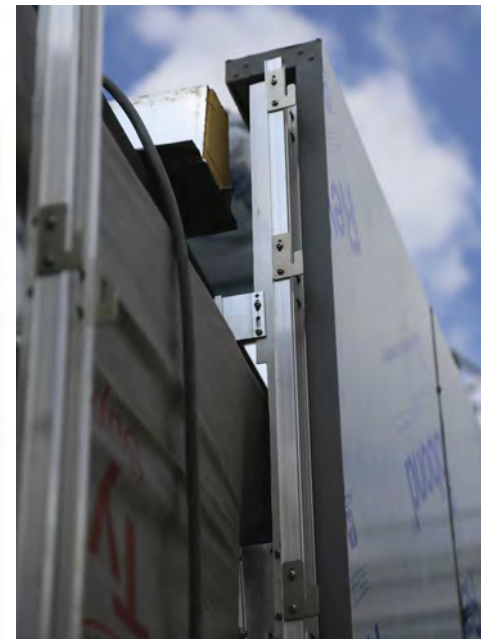

In QUARTZ-ZINC and PIGMENTO finishes

Maximum sheet size: 1250 x 6000mm

In ANTHRA-ZINC and AZENGAR finishes

Maximum sheet size: 1000 x 6000mm

- 1 VMZ Composite panel
- 2 Fixing clip
- 3 Metal framing creating a vented 38mm airspace
- 4 VMZINC Membrane
- 5 Insulation
- 6 Supporting structure (blockwork as shown or metal framing or other appropriate supporting structure)

Advantages of the VMZ composite system

- Very large flat panels
- Option of concealed fasteners
- Suitable for complex panel shapes
- Horizontal and vertical installation possible
- Fire rated EN 13501-1 B-s1,d0 (QUARTZ-ZINC, ANTHRA-ZINC and AZENGAR)
- Peel test to ASTM D-903

For more information contact us on
0203 445 5640
or send an e-mail to
vmzinc.uk@vmbuildingsolutions.com

VMZ Facade

VMZ composite

Overview VMZ Composite material consists of two layers of 0.5mm thick pre-weathered zinc and a fire rated 3mm mineral rich polyethylene core. The material is available in QUARTZ-ZINC, ANTHRA-ZINC, AZENGAR and the 5 PIGMENTO colours. The stiffness of VMZ Composite allows very large and exceptionally flat panels to be manufactured and installed. However the nature of composite material also allows it to be folded into complex and yet rigid shapes. Standard panels can be up to 3900mm x 900mm in size, however it is possible to extend this to 5900mm and 1100mm. It should be noted that 1100mm wide panels are only available in QUARTZ-ZINC and PIGMENTO.

VMZ Composite is always installed using the rainscreen principal with a vented air space of at least 38mm between the back of the panels and the insulation or solid structure. Panels can be installed both horizontally as well as vertically. The panels can also be fixed with visible fasteners or using a cassette system with hidden fixings. VMZINC Composite can also be fixed using a structural bond (vertical panels only) thus providing another secret fix option.

Structure The system is lightweight as the panels weigh no more than 13 kg/m² and are generally fixed to aluminium cladding rails with a thickness of at least 2mm. The zone behind the panels must be vented and at least 38mm deep.

Installation The panels are installed on cladding rails. The exact dimensioning of the rails and brackets will depend on loadings and panel orientation. Vertical panels are generally installed using a hook and pin principal whereas horizontal panels rely on a continuous rail. Depending on the system used, individual panels may be independently removable. Standard panel installation is bottom up with the standard joint width being 20mm.

The panels should be installed with the protective film in place.

VMZINC PLUS must be used on all non-vertical flashings if open gap soft boards are not being used.

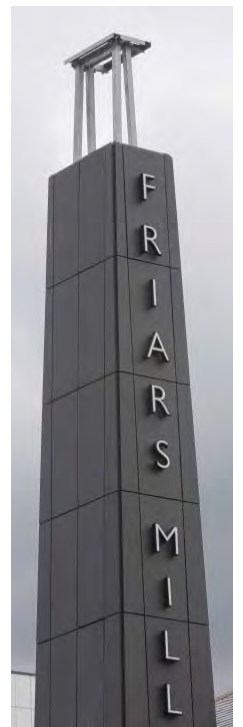

VMZ Facade

VMZ composite

Download the technical drawings of this facade build-up from our website www.vmezinc.co.uk

Vertical section

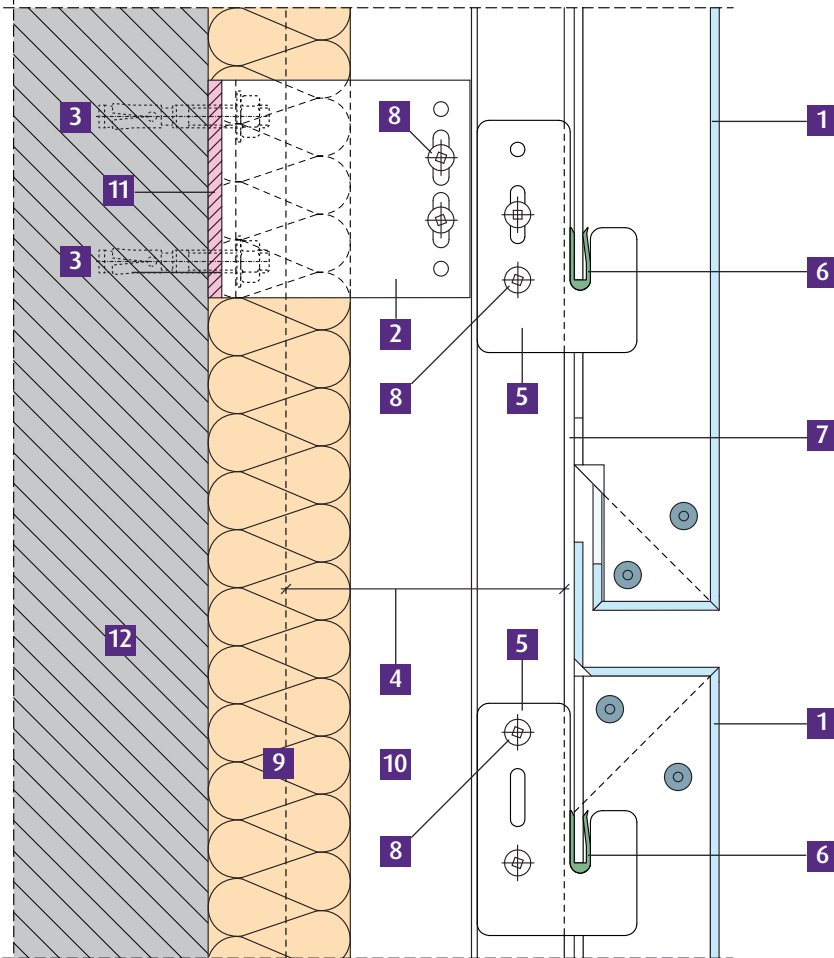

- 1** VMZINC Composite material
- 2** Nvelope fixing bracket
- 3** Stainless steel fixing
- 4** Cassette vertical support rail
- 5** Hook plate
- 6** PVC anti-rattle clip
- 7** Alignment gasket
- 8** Self drilling stainless steel screw 4.8 x 19
- 9** External insulation
- 10** Ventilated cavity
- 11** Thermal break
- 12** Loadbearing structure

UK fabricators can offer a complete facade system in VMZ Composite

Horizontal section

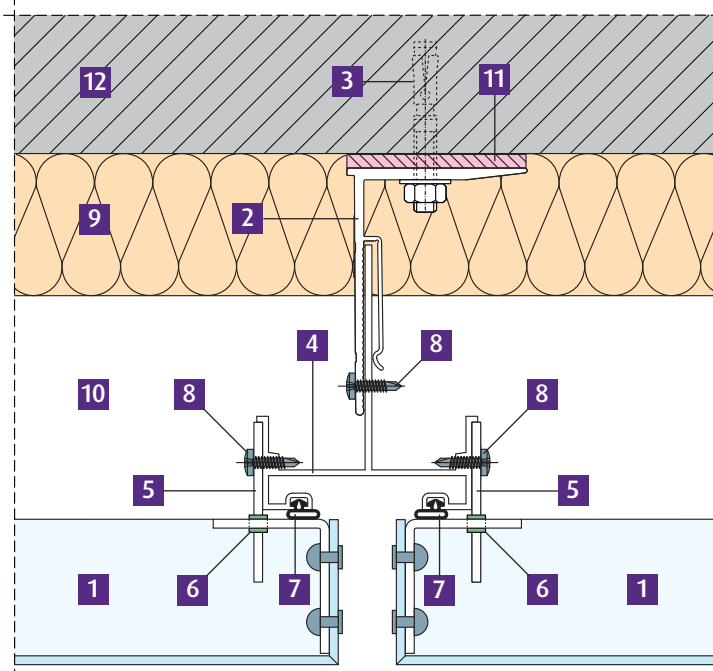

- 1** VMZINC Composite material
- 2** Nvelope fixing bracket
- 3** Stainless steel fixing
- 4** Cassette vertical support rail
- 5** Hook plate
- 6** PVC anti-rattle clip
- 7** Alignment gasket
- 8** Self drilling stainless steel screw 4.8 x 19
- 9** External insulation
- 10** Ventilated cavity
- 11** Thermal break
- 12** Loadbearing structure

VMZ Facade Mozaik

Typical
Mozaik cassette
system
construction

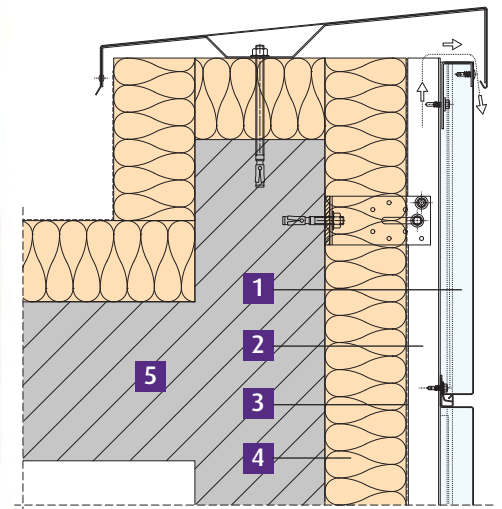

Maximum panel size: 600 x 2400mm

- 1** VMZINC Mozaik cassette panels
- 2** Metal framing creating a vented 38mm airspace
- 3** VMZINC Membrane
- 4** Insulation
- 5** Supporting structure (blockwork as shown or metal framing or other appropriate supporting structure)

Advantages
of a typical
Mozaik cassette
system

- Wide range of panel sizes and depths
- Concealed fastening
- All finishes available
- Bespoke perforation possible

For more information contact us on
0203 445 5640
or send an e-mail to
vmzinc.uk@vmbuildingsolutions.com

VMZ Facade

Mozaik

Overview Mozaik is a rainscreen cassette system that is available in all finishes of 1mm thick VMZINC and can be installed both vertically and horizontally. The maximum panel size is 2400mm x 600mm and panels can have a depth of 40, 60, 80 or 100mm. Vertical and horizontal joints are 15mm. Timber battens can be used to support the panels but metal rails are more commonly used (2mm aluminium or 1.5mm galvanised steel). Centre to centre spacing of the rails is typically 600mm but can vary depending on the loading requirements of the facade in question.

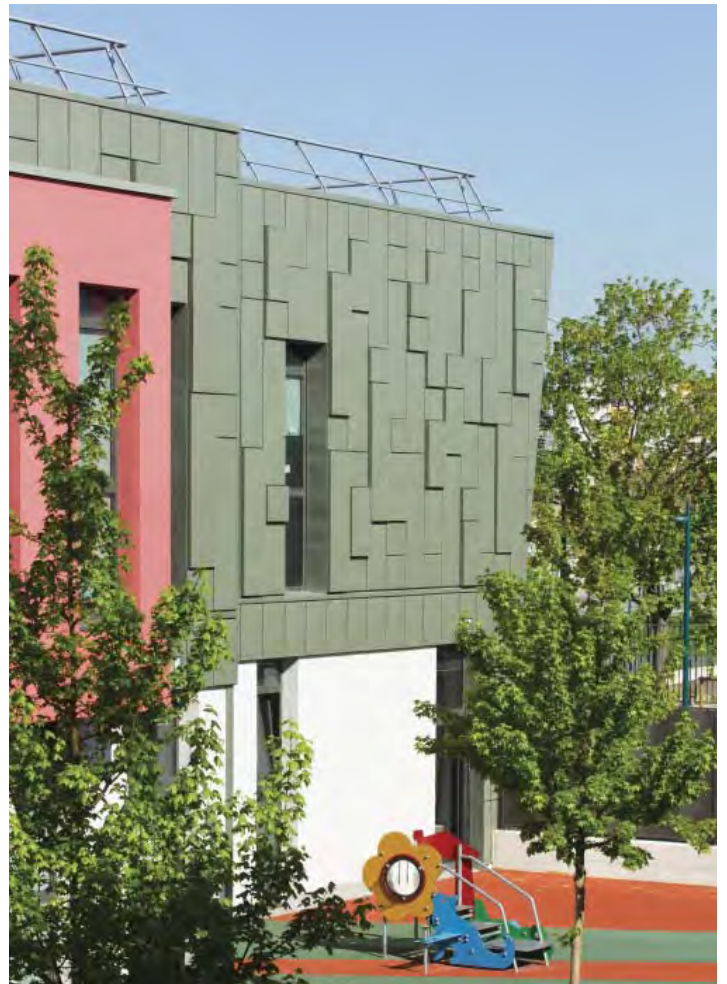

VMZ Facade

Customised panels

Perforated panels Almost all VMZINC rainscreen facade panels can be perforated. This can vary from standard perforations to custom perforations creating various patterns, even images and logos.

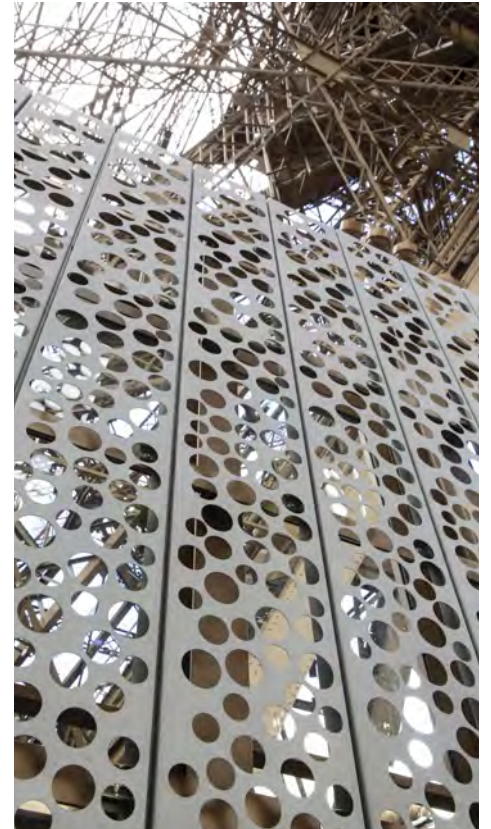

VMZ Facade

Customised panels

Perforated
VMZ Composite
in QUARTZ-ZINC



Perforated
QUARTZ-ZINC



VMZ Facade

Customised panels

Curved VMZ Composite in PIGMENTO Green



Custom-formed VMZ Composite in QUARTZ-ZINC



VMZ Facade

Customised panels

Curved
interlocking
panels in
ANTHRA-ZINC,
QUARTZ-ZINC and
Natural VMZINC



Custom-stamped
Natural VMZINC
standing seam
roofing and wall
cladding panels



VMZ Facade

Interlocking panel

Typical interlocking panel system construction

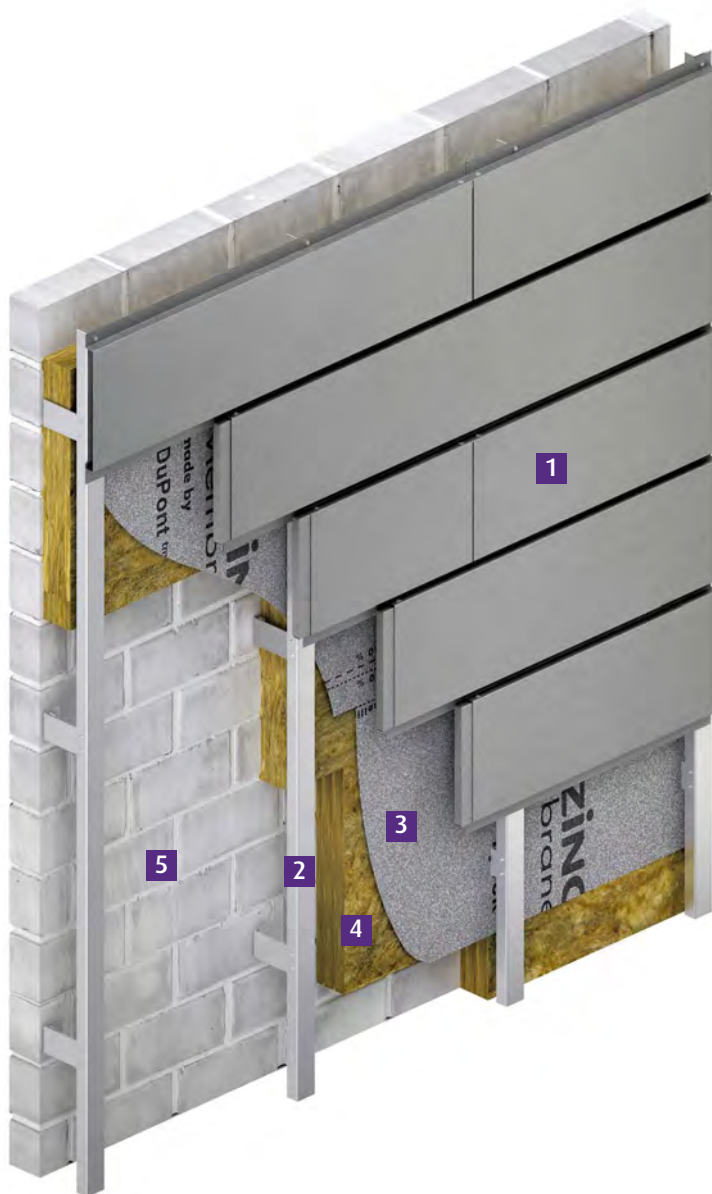

Maximum panel size: 333 x 6000mm

- 1 VMZINC interlocking panels
- 2 Metal framing creating a vented 38mm airspace
- 3 VMZINC Membrane
- 4 Insulation
- 5 Supporting structure (blockwork as shown or metal framing or other appropriate supporting structure)

Advantages of the interlocking panel system

- Elegant linear panels
- Concealed fastening
- CWCT tested by UK fabricators
- Variable joint size
- Horizontal and vertical installation possible

For more information contact us on
0203 445 5640
or send an e-mail to
vmzinc.uk@vmbuildingsolutions.com

VMZ Facade

Interlocking panel

Overview Interlocking Panels consist of a panel face, reveal joint and are fixed in position using hidden fasteners. The panels can be orientated horizontally or vertically and can be applied equally to soffits. Panels are available in all finishes of 1mm thick VMZINC with standard panel widths being 200mm, 250mm and 300mm. The maximum panel width is 333mm and length 6m, panels of less than 0.5m are not recommended. Joint widths can be either 10mm or 20mm. It should be noted that panel width = panel face + joint. The depth of the panel is 25mm.



VMZ Facade

Interlocking panel

Structure The system is relatively lightweight as the panels weigh no more than 12 kg/m² and can be fixed back to both timber and metal sub frames. Support rails are installed at 600mm centres (maximum). Aluminium rails are 2mm thick with both timber and aluminium rails requiring a supporting face of at least 40mm. All panels that are over 2m in length must allow for thermal expansion and contraction by using stainless steel clips. The fixed point being at the top of the panel for vertical installation and in the middle for horizontal installation.

Installation The panels are installed in a sequential order from top to bottom for horizontal panels. The upper edge of each panel is engaged into the lower edge of the panel above. The panels are mechanically attached using screws and/or the panel fixing clip that allows for thermal movement. The panels should be installed with the protective film in place.

VMZINC PLUS must be used on all non-vertical flashings if open gap soft boards are not being used.

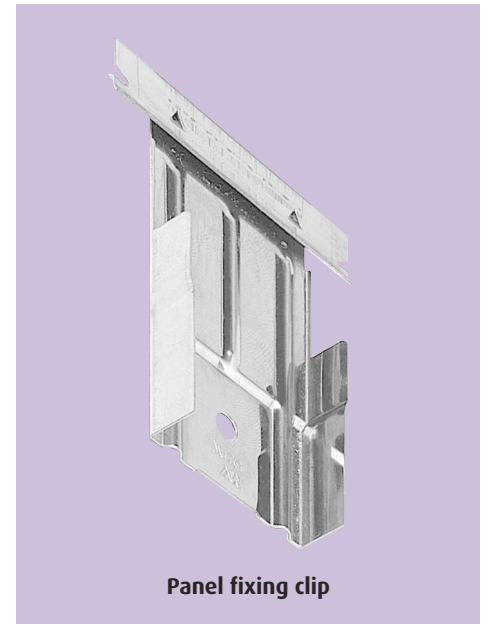

VMZ Facade

Interlocking panel

Download the technical drawings of this facade build-up from our website www.vmzinc.co.uk

Parapet detail

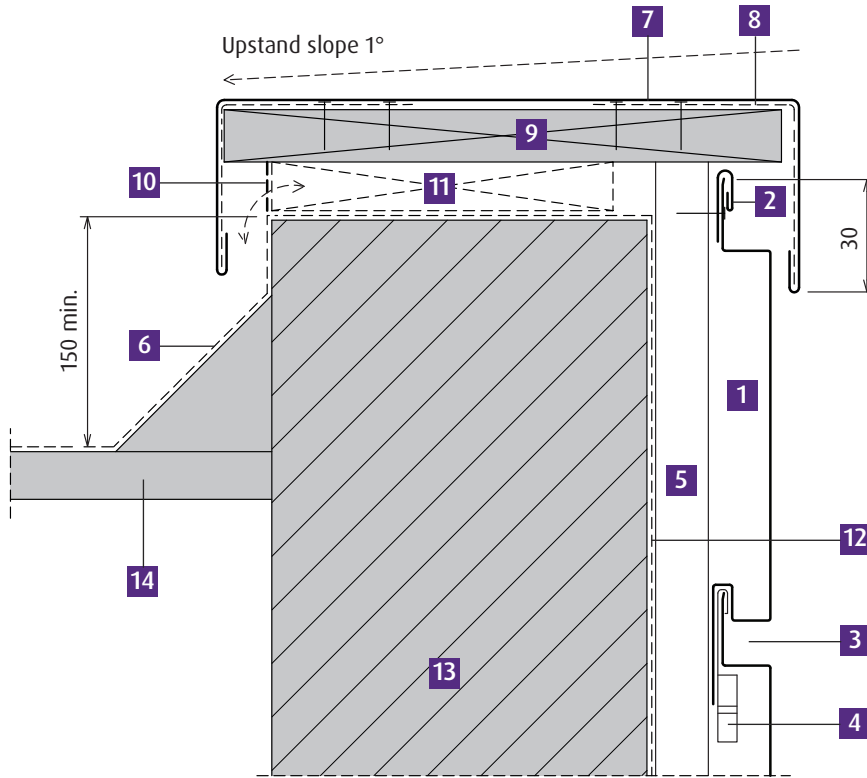

- 1** VMZINC Interlocking Panels
- 2** VMZINC continuous welded strip
- 3** 10 or 20mm joint
- 4** Panel fixing clip
- 5** Timber or metal framework
- 6** Roofing membrane
- 7** VMZINC capping piece max 500mm wide
- 8** VMZINC folded clip, 1mm thick, width 250mm, 2 per m
- 9** Roof boarding
- 10** Insect mesh
- 11** Intermittent timber fixing packs to provide ventilation pathways
- 12** VMZINC Membrane
- 13** Loadbearing structure
- 14** Roof deck

Window details

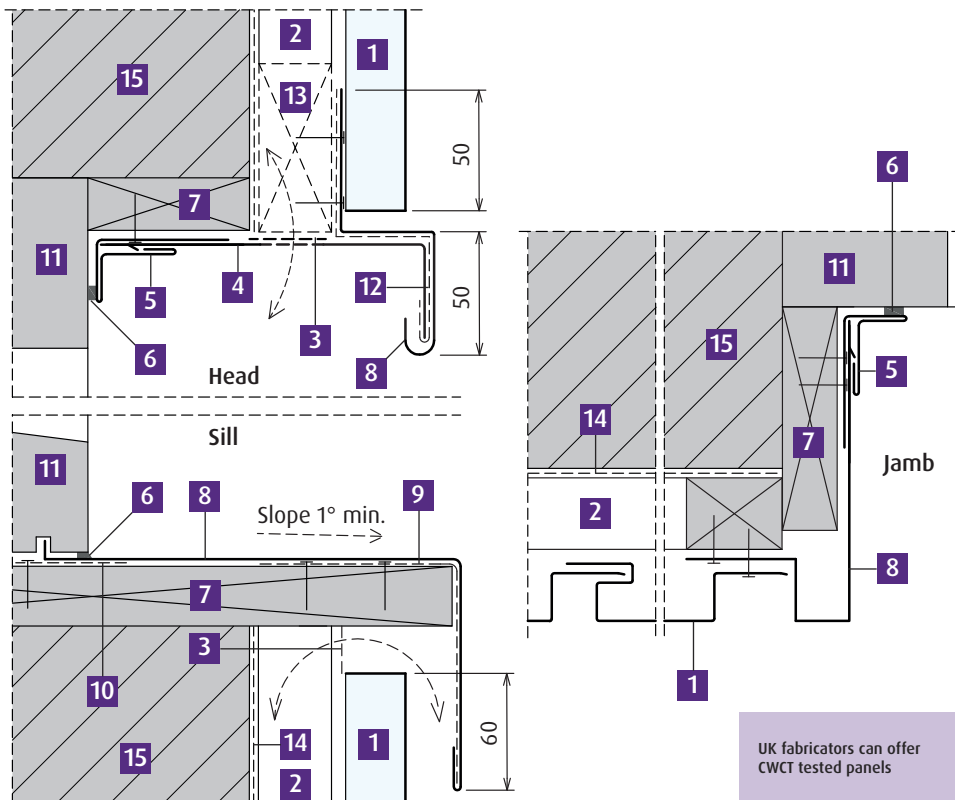

- 1** VMZINC Interlocking Panels
- 2** Timber or metal framework
- 3** Insect mesh
- 4** VMZINC welded panels with perforated grids
- 5** VMZINC cover profile
- 6** Compatible mastic seal
- 7** Timber fixing pack
- 8** VMZINC flashing
- 9** VMZINC folded clip, 1mm thick, width 250mm, 2 per m
- 10** VMZINC soldered clip
- 11** Window frame
- 12** VMZINC sheet clip, 0.8mm thick, width 80mm, 2 per m
- 13** Intermittent timber fixing packs to provide ventilation pathways
- 14** VMZINC Membrane
- 15** Loadbearing structure

All dimensions in mm

UK fabricators can offer CWCT tested panels

VMZ Facade

Sine wave

Typical
sine wave
system
construction

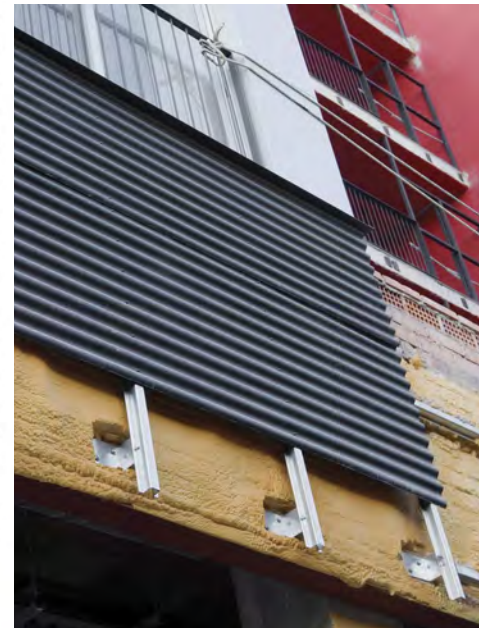

Maximum panel size: 836 x 6000mm

- 1 VMZ Sine Wave panel
- 2 Stainless steel screw
- 3 Metal framing creating a vented 38mm airspace
- 4 VMZINC Membrane
- 5 Insulation
- 6 Supporting structure (blockwork as shown or metal framing or other appropriate supporting structure)

Advantages of the sine wave system

- Offers a more industrial aesthetic
- Very simple installation
- Cost effective
- Available in all finishes

For more information contact us on
0203 445 5640
or send an e-mail to
vmzinc.uk@vmbuildingsolutions.com

VMZ Facade

Sine wave

Overview VMZ Sine Wave is a corrugated profile in zinc that can be fixed to a wooden or a metal framework. Along with face fixed VMZ Composite sheets this is one of the few VMZ facade systems that relies on visible fasteners. The standard profile for the panel is an 18/76mm module which is available in both 0.8mm and 1mm thicknesses. The system can be used to clad walls both horizontally and vertically. Sine Wave can be installed on a roof, however a secondary waterproofing layer is required.

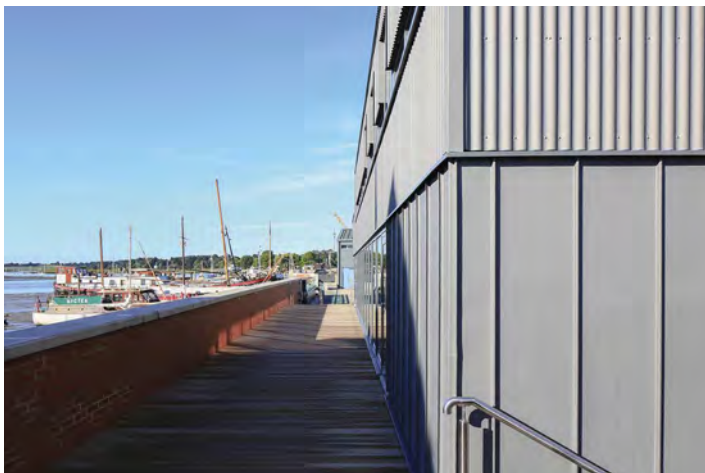

VMZ Facade

Sine wave

Structure The system is fixed back to timber or metal (galvanised steel at least 1.5mm thick or aluminium at least 2mm thick) rails that are typically at centres of between 0.8m and 1.2m (depending on loading). The rails must have a supporting face width of 40mm and should allow a minimum vented space between the VMZ Sine Wave panel and the insulation/sheathing of 38mm.

Installation The panels are installed in a sequential order from bottom up. Panels are fixed in place with stainless steel screws on every other wave. The maximum length for the panels is 6m. For panels over 3m in length slotted or over-size holes must be pre-drilled to allow the thermal expansion and contraction of the panels to take place.

The panels should be installed with the protective film in place.

VMZINC PLUS must be used on all non-vertical flashings if open gap soft boards are not being used.

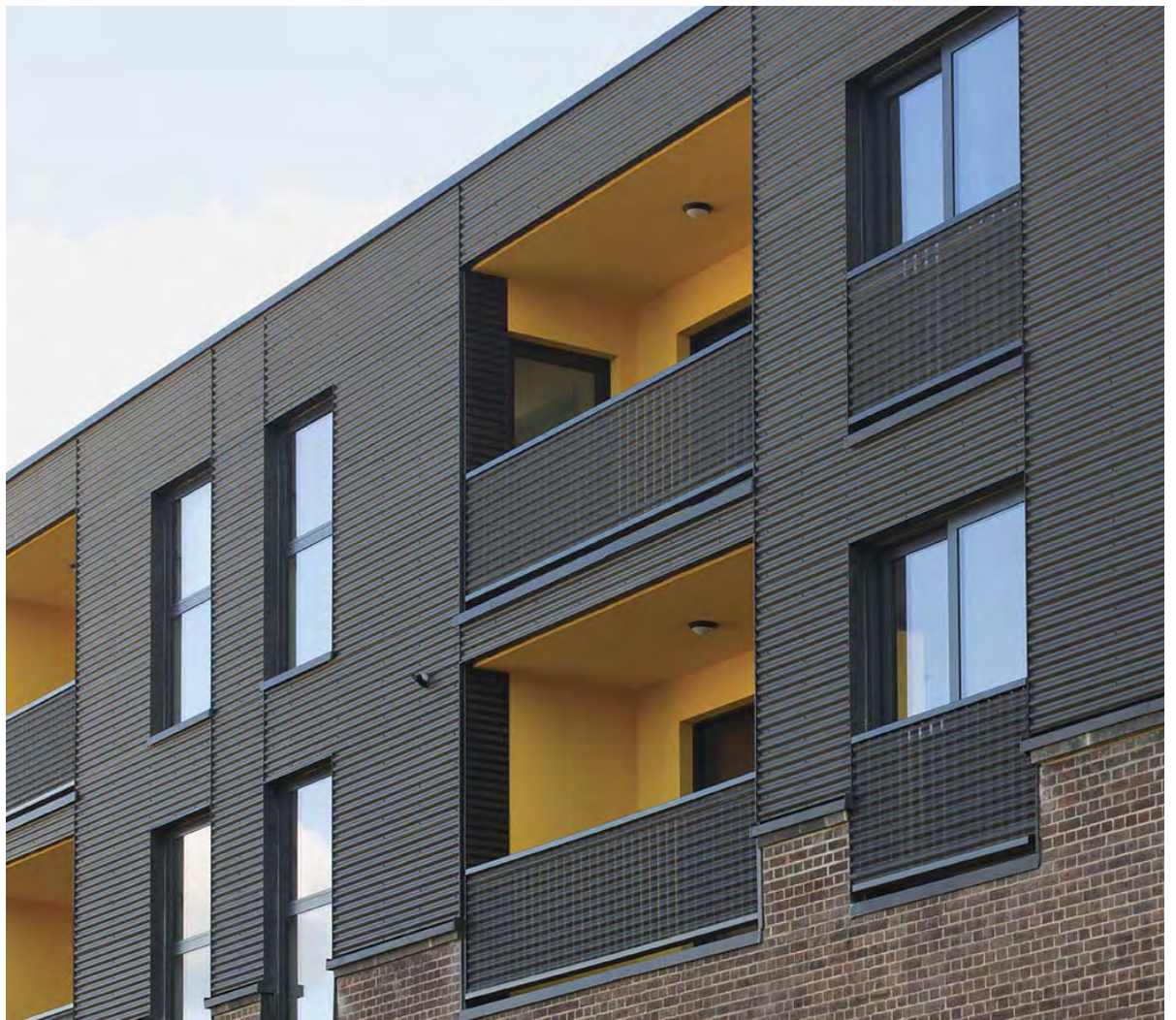
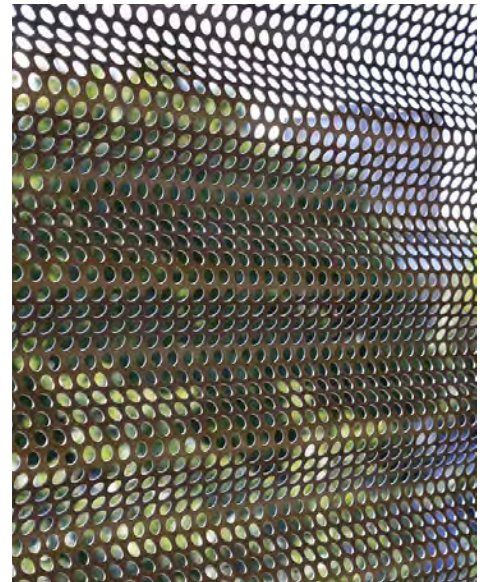

VMZ Facade

Sine wave

Download the technical drawings of this facade build-up from our website www.vmzinc.co.uk

Expansion joint detail

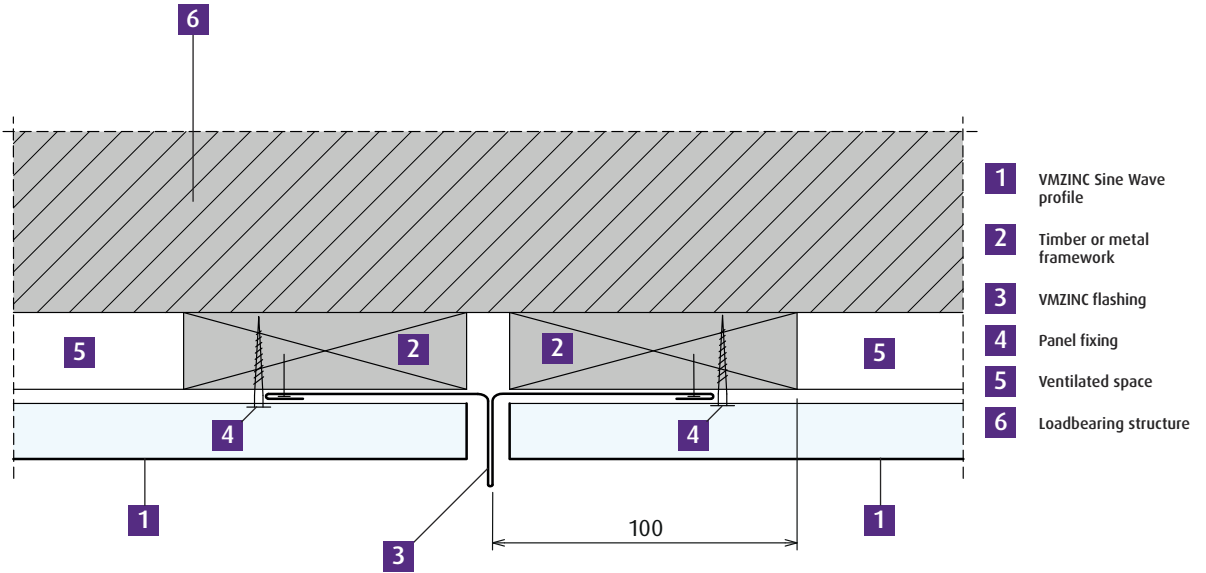

- 1 VMZINC Sine Wave profile
- 2 Timber or metal framework
- 3 VMZINC flashing
- 4 Panel fixing
- 5 Ventilated space
- 6 Loadbearing structure

Window details

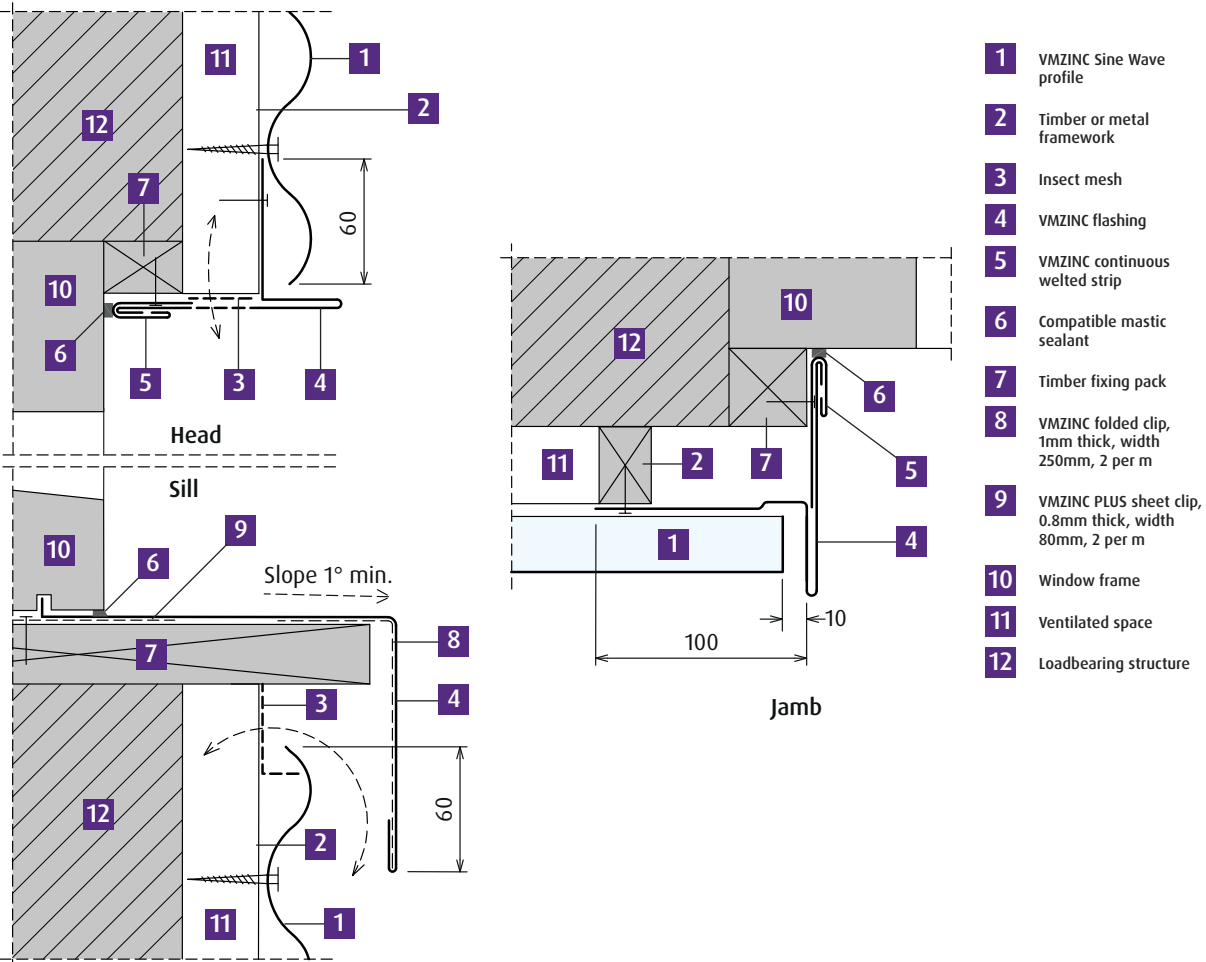

- 1 VMZINC Sine Wave profile
- 2 Timber or metal framework
- 3 Insect mesh
- 4 VMZINC flashing
- 5 VMZINC continuous welded strip
- 6 Compatible mastic sealant
- 7 Timber fixing pack
- 8 VMZINC folded clip, 1mm thick, width 250mm, 2 per m
- 9 VMZINC PLUS sheet clip, 0.8mm thick, width 80mm, 2 per m
- 10 Window frame
- 11 Ventilated space
- 12 Loadbearing structure

All dimensions in mm

VMZ Facade

Overlapping panel

Typical overlapping panel system construction

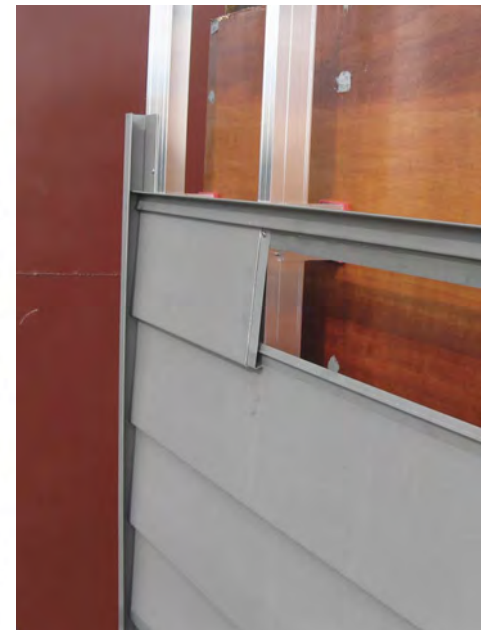

Panel size: 200 x 3000mm

- 1 VMZINC overlapping panels
- 2 Timber framing creating a vented 38mm airspace
- 3 VMZINC Membrane
- 4 Insulation
- 5 Supporting structure (blockwork as shown or metal framing or other appropriate supporting structure)

- Advantages of the overlapping panel system**
- Cost effective
 - Concealed fastening
 - Full system available in stock

For more information contact us on
0203 445 5640
or send an e-mail to
vmzinc.uk@vmbuildingsolutions.com

VMZ Facade

Overlapping panel

Overview The Overlapping Panel system comprises of an economical kit of panels and flashings that can be easily installed on either timber battens or metal cladding rails. The system is fixed with screws or with a nail gun resulting in the panels being held in place with no visible fasteners. Overlapping panels are 200mm wide and have either a depth of 13mm or 20mm. They are installed horizontally and available in 3m lengths in both QUARTZ-ZINC and ANTHRA-ZINC. Overlapping panels can be supplied in PIGMENTO/AZENGAR upon request.



VMZ Facade

Overlapping panel

Structure The overlapping panels are installed on vertical cladding rails at 600mm centres. The rails can be either softwood timber with a 50mm supporting width or 40mm wide metal rails (2mm thick Aluminium or 1.5mm thick galvanised steel). A vented air space of at least 38mm must be allowed for behind the panels.

Installation In a sequential order the panels are installed from bottom to top and fixed with a nail gun for timber supports and screwed into position when using metal cladding rails. The panels should be installed with the protective film in place. A full set of standard flashing trim is available for base, top, corners and windows.

VMZINC PLUS must be used on all non-vertical flashings if open gap soft boards are not being used.



VMZ Facade

Overlapping panel

Download the technical drawings of this facade build-up from our website www.vmzinc.co.uk

Top and base edge details

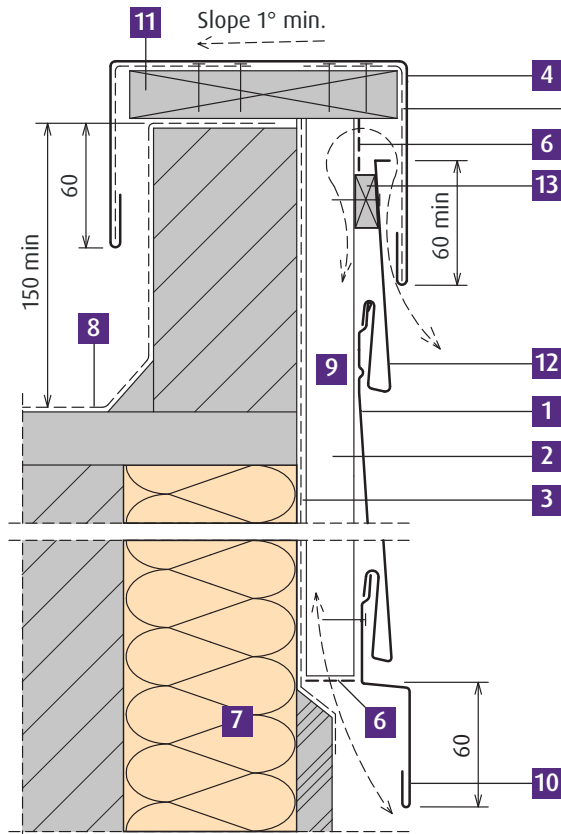

- 1** VMZ Overlapping Panel
- 2** Batten, 38mm thick, width 50mm
- 3** VMZ Membrane
- 4** VMZINC PLUS capping piece
- 5** Fixing clip
- 6** Insect mesh
- 7** Thermal insulation
- 8** Roof membrane (this can be cut back)
- 9** Ventilated space
- 10** Eaves apron strip
- 11** Timber support with fall
- 12** Modified panel
- 13** Timber block

Window details

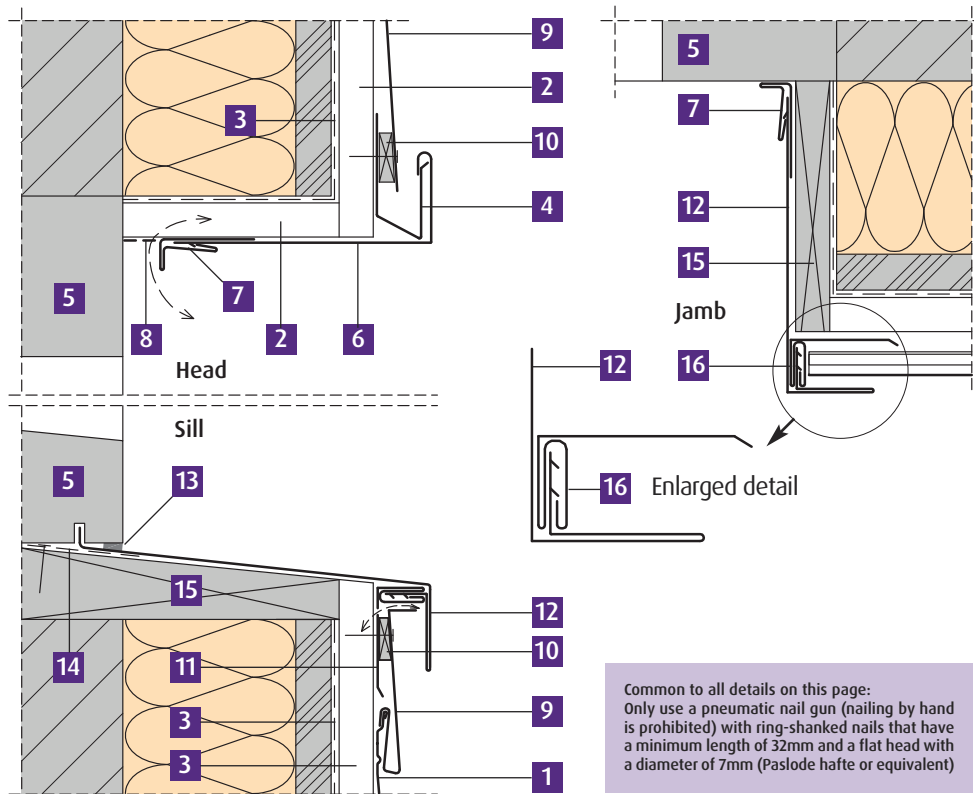

- 1** VMZ Overlapping Panel
- 2** Ventilated space
- 3** VMZ Membrane
- 4** VMZ Unicprofile F6
- 5** Window frame
- 6** VMZ Unicprofile F7 (adapted)
- 7** VMZ Unicprofile F4
- 8** Insect mesh
- 9** Modified VMZ Overlapping panel
- 10** Timber block
- 11** VMZ Unicprofile F1 (adapted)
- 12** VMZ Unicprofile F2 (adapted)
- 13** Compatible flexible sealant
- 14** Clip
- 15** Timber board with fall
- 16** VMZ Unicprofile F1

Common to all details on this page:
Only use a pneumatic nail gun (nailing by hand is prohibited) with ring-shanked nails that have a minimum length of 32mm and a flat head with a diameter of 7mm (Paslode hafte or equivalent)

All dimensions in mm

VMZ Facade

Further technical information

Zinc aesthetics Zinc is a material that requires almost no maintenance as the rinsing effect of rainwater performs this task naturally. However when zinc is used on a non rinsed surface such as a protected facade or soffit it is possible that the zinc may exhibit some superficial stains. These stains will not affect the integrity of the zinc itself. It is for this reason that the very dark grey ANTHRA-ZINC should be carefully considered before being designed on a non rinsed facade or soffit. In marine locations the risk of superficial staining in these areas increases. Whilst stains are possible on QUARTZ-ZINC and the PIGMENTO range the visual effect is greatly reduced and therefore these finishes may be more appropriate for some specific locations, however in a severe non-rinsed marine environment (1km from the sea), staining is still possible and therefore PIGMENTO should not be used in this application.

Zinc can be installed adjacent to limestone. The run off from limestone onto zinc material is acceptable. However, limestone dust and gypsum dust generated during cutting operations can react with zinc in the presence of water and form a superficial layer of white rust. No dust should be in contact with unprotected zinc. To prevent white rust, good construction practices should be used to limit the amount of dust that comes in contact with the zinc.

VMZINC manufacturing uses a colour management system based on the Y-Factor. The Y-factor ranges from 0 to 100: 0 is black and 100 is white. The range for ANTHRA-ZINC is 5 to 7 and the range for QUARTZ-ZINC is 22 to 25. Variations are possible within this range when different production batches are used.

Protective film All VMZINC facade systems are supplied with a protective film. We recommend that the film be left on the panels during installation. The film should only be removed when other trades are no longer working in the vicinity of the completed zinc facade. The film must not be partially removed as this will lead to unsightly stains. Panels adjacent to one another must not be left with one filmed and the other unfiled. The zinc facade panels should be delivered to site with the film completely covering panel faces but not so as to obstruct film removal in joints. The protective film can left on the panels for up to 2 months after panel installation.

VMZINC Membrane VMZINC Membrane is a breather layer that allows water vapour to pass through it but is water proof to liquid water (up to a column of 2m). VMZINC Membrane should be used to protect the internal leaf of the rainscreen wall which is often the insulation.

Fire protection Whilst zinc has a fire performance rating 'AA' - BS 476: Part 3 ('low vulnerability' class in Scotland) and has a fire classification of A1 or A2-s1,d0 when used on a vented wall it may be necessary to address fire risks created by the vented cavity. This can be dealt with by creating flashings that compartmentalise the vented cavity or by using intumescent fire barriers that maintain the ventilated cavity in normal conditions, leaving the 38mm continuous free air space, but, in the event of fire, the intumescent ventilated fire barriers quickly expand to seal off the cavity to prevent fire spread. Not all fire retardant materials are compatible with zinc, therefore please contact us should you require project-specific information.

VMZINC in relation to other materials

Compatible contact products
Metals
Lead
Aluminium (painted, anodised or bare)
Galvanised steel
Stainless steel
Woods
Pine
Spruce
Scots pine
Poplar
Miscellaneous materials
Polyurethane
Non-acetic silicones
MS polymer mastics
Organic timber treatments

Incompatible contact products & run-off*
Metals
Copper
Steel (non-galvanised)
Gypsum dust/limestone dust
Woods
Larch
Oak
Chestnut
Red cedar
Douglas fir
White cedar
All woods with a pH < 5
Miscellaneous materials
Mortar
Building paper
Bituminous membranes
Fire retardant & preservative treatments
Acidic cleaners (brick cleaner etc)
Acetic silicones
Metal salt timber treatments

* This list is not exhaustive

VMZ Facade

Other VMZINC systems

Roofing systems VMZINC has been used as a roofing system for almost 200 years. The most common system is standing seam roofing. However, for heritage projects, batten cap roofing is a popular option.



Ornaments VMZINC ornaments were first made by 19th century workshops in Paris. The tradition continues with VMZINC ornaments fabricating both standard and bespoke ornaments that are sent to all corners of the world.



Rainwater systems Whether for new build or refurbishment, VMZINC rainwater systems have been designed to complement a wide range of building materials and styles. Pre-weathered finishes offer exceptional colour stability while developing the natural, self-protecting patina for which zinc is renowned. This ensures that maintenance requirements will be minimal throughout the systems' design life and that the material's installed appearance will be retained for many years.





Subject

The subject of this document is intended for specifiers (building project architects and design teams) and installers (specialist companies responsible for installation on the building site) of the designated product or system. Its purpose is to provide the main information, text and diagrams, relating to specification and installation. Any use or specification outside the area of use and/or specifications contained in this brochure requires specific consultation with the VMZINC technical departments. This does not commit the latter to any responsibility with regard to the feasibility of the design or implementation of these projects.

Countries of application

This document applies exclusively to the specification and installation of the designated products or systems on building sites in the United Kingdom and the Republic of Ireland.

Qualifications and reference documents

Please note that the specification of all construction systems for a given building remains the exclusive responsibility of its design team, who must, in particular, ensure that the specified products are suitable for the purpose of the building and compatible with the other products and techniques used. Please note that the correct use of this manual requires knowledge of VMZINC materials and of the zinc roofing profession. While construction is underway all standards in force must be respected. A video showing the installation process is available via download from www.vmzinc.co.uk or www.vmzinc.ie. Furthermore, VM Building Solutions offers training courses specifically for professionals.

Responsibility

The specification and installation of VMZINC products manufactured by VM Building Solutions are the sole responsibility of the architects and building professionals who must ensure these products are used in a way suited to the end purpose of the construction and that they are compatible with other products and techniques used. The specification and installation of the products implies respecting the standards in force and the manufacturer's recommendations. In this regard, VM Building Solutions publishes and regularly updates specification and installation manuals for specific geographic areas and provides training courses. Further information concerning the design and installation of VMZINC is available at www.vmzinc.co.uk. Unless otherwise agreed in writing, VM Building Solutions cannot be held responsible for any damages resulting from a specification or installation that does not respect all of VM Building Solutions specifications and the above standards and practices.

